

User Manual



BLUETOOTH® SMART DIGITAL SCALE



**Product
Info**



www.aldi.com.au

+ VIDEO

QR codes take you where you want to go quickly and easily

Whether you require **product information**, **spare parts** or **accessories**, details on **warranties** or **aftersales services**, or if you want to watch a **product demonstration video**, our QR codes will take you there in no time at all.

What is a QR code?

A QR code (QR = Quick Response) is a type of matrix that can be read with a smartphone camera and that contains a link to a website or contact details, for example.

Advantage: You do not need to manually enter a website address or contact details.

How it works

To scan the QR code, all you need is a smartphone with QR code reader software and an internet connection.

This type of software can be downloaded for free from your smartphone's app store.

Try it out now

Just scan the QR code with your smartphone and find out more about the Aldi product you have purchased.

Your Aldi Service Portal

All details mentioned above can also be found in the Aldi Service Portal at www.aldi.com.au.



Depending on your tariff plan you may be charged for the connection.

Contents

Overview	4	Setting the level of activity ..	18
Use	5	Performing a measurement	20
Pack contents/device parts ..	6	Evaluating the measurements	22
General information.....	7	Restrictions	22
Reading and storing the user manual	7	Body mass index (BMI)	22
Explanation of symbols.....	7	Body fat percentage	24
Safety	8	Body water percentage	25
Proper use.....	8	Muscle percentage	26
Safety instructions.....	8	Bone mass.....	26
Checking the scale and pack contents.....	11	Basal metabolic rate (BMR)	27
Scale and Crane Connect app	12	Active metabolic rate (AMR)	27
Functions.....	12	Measurements in relation to one another	28
Measurement method	12	Cleaning and maintenance .	29
Compatibility.....	13	Changing the batteries	30
Use without app.....	14	Storage.....	30
Setup	14	Troubleshooting.....	31
Inserting batteries.....	14	Technical data	35
Setting up the scale.....	15	Disposal.....	36
Affixing the carpet feet.....	15	Disposing of the packaging.....	36
Setting the unit of measure for weight.....	15	Disposing of old appliances	36
Resetting the scale memory	15	Warranty details	37
Installing the app.....	16	Repair and refurbished goods or parts notice.....	38
Creating a user account	16		
Handling	17		
Establishing a Bluetooth® connection.....	17		
Creating multiple users in the app.....	18		

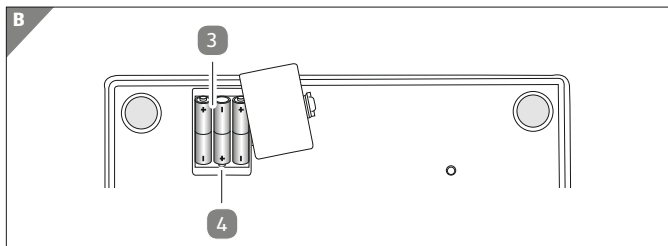
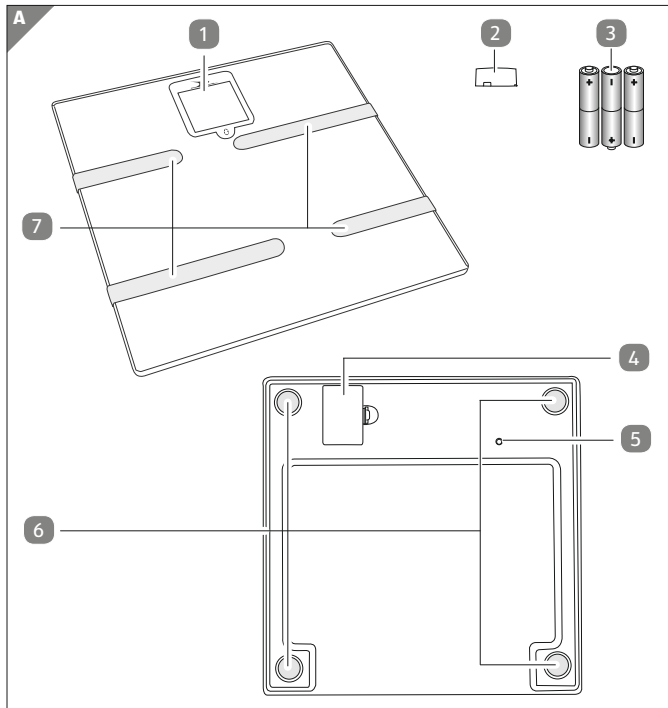

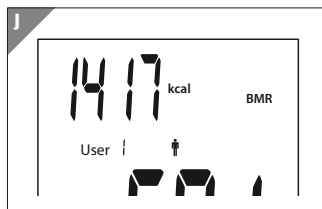
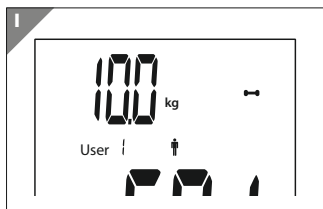
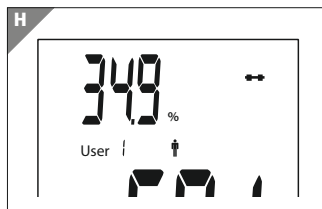
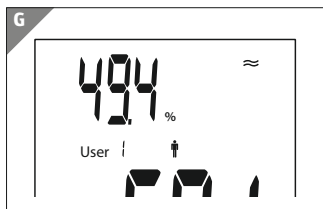
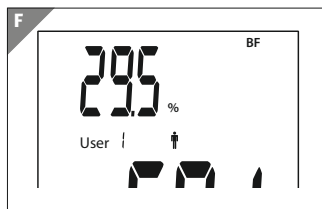
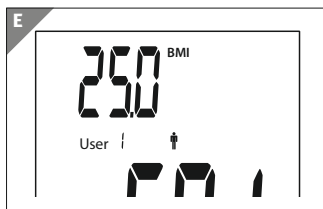
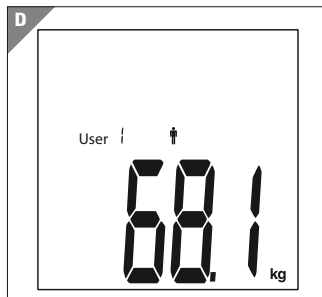
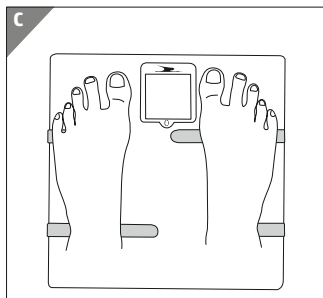

Pack contents/device parts

- 1 Display
- 2 Carpet feet, 4×
- 3 Batteries, 3×
- 4 Battery compartment
- 5 Reset button
- 6 Support feet
- 7 Measurement electrodes



The pack contents include three type LR03/R03/AAA 1.5 V batteries.

General information

Reading and storing the user manual



This user manual accompanies this Bluetooth® smart digital scale. It contains important information on setup and use.

For improved readability, the Bluetooth® smart digital scale will be referred to below merely as the “scale”.

Carefully read through the user manual, particularly the safety instructions, before you use the scale. Failure to comply with the user manual may result in damage to the scale.

Store the user manual for further use. If you pass the scale on third parties, please be absolutely sure to include this user manual.

Explanation of symbols

The following symbols and signal words are used in this user manual, on the scale or on the packaging.

 **WARNING!**

This signal symbol/word designates a hazard with moderate risk, which may result in death or severe injury if not avoided.

NOTICE!

This signal word warns against potential damages to property.



This symbol provides you with useful supplementary information on assembly or operation.



This symbol indicates that the warranty for the scale amounts to 36 months (3 years).

Safety

Proper use

The scale is designed exclusively for use as an aid for measuring and displaying your physiological data. The scale is exclusively intended for private use and is not suitable for commercial or clinical use. The scale is not a medical device and is not a toy.

Only use the scale as described in this instruction manual. Any other use is deemed improper and may result in injury to persons or damage to the scale.

The manufacturer or vendor accepts no liability for damage caused by improper or incorrect use.

Safety instructions



Risk of injury!

Failure to use the scale properly poses a substantial risk of injury.

- Do not use the scale if you rely on medical implants (e.g. a pacemaker). The voltage used for measurements in the bioelectric impedance analysis of the scale may interfere with the functions of such implants.
- Do not use the scale if you are pregnant.
- Do not stand on the outer edge of one side of the scale.

-
- Do not stand on the scale if your feet are wet or if you have applied cream to them.
 - Dry off the surface of the scale before you use it.
 - Discontinue using the scale if it exhibits visible damages.

 **WARNING!**

Risks associated with using batteries!

The scale is battery-operated. Improper handling of the batteries may result in injury and damage to property.

- Store the batteries in an area that is not accessible for children. If you suspect that a child has swallowed a battery, immediately contact a physician.
- Never expose the batteries to excessive heat such as direct sunlight, open flames or similar.
- Do not charge the batteries or reactivate them with other means.
- Do not short circuit the batteries.
- Do not open the batteries.
- To prevent the batteries from leaking, only insert batteries of the same type in the scale.

- Promptly remove empty batteries from the scale.
- Do not allow battery acid to come into contact with skin, eyes or mucus membranes. In the event of contact with battery acid, immediately flush the applicable areas with plenty of clean water and consult a physician if necessary.
- If batteries in the scale leak, use gloves to remove them. Afterwards, clean the battery compartment with a cloth without water or any cleaners.
- If you do not use the scale for a prolonged period, remove the batteries from the battery compartment.

NOTICE!

Risk of damage!

Improper use of the scale may result in damage.

- Do not expose the scale to strong magnetic fields (e.g. transformers). Otherwise this could cause errors in data transmission or damage to the scale.
- Do not open the scale.

- Do not immerse the scale in water and do not rinse it off under running water.
- Protect the scale against impacts and chemicals.
- Do not expose the scale to extreme temperature fluctuations.
- Do not set up the scale near strong heat sources (e.g. ovens or radiators).
- Do not place any objects on the scale when you are not using it.

Checking the scale and pack contents

NOTICE!

Risk of damage!

If you are not cautious when opening the packaging with a sharp knife or other pointed objects, you may quickly damage the scale.

- You should therefore be very careful when opening it.
 1. Take the scale and its accessories out of the packaging.
 2. Remove the packaging material.
 3. Check to make sure that the delivery is complete (see **fig. A**).
 4. Check whether the scale or the individual parts exhibit damage. If this is the case, do not use the scale. Contact the manufacturer at the service address specified on the warranty card.

Scale and Crane Connect app

The scale is designed for weighing and for the diagnosis of individual physical data. The data measured are transmitted to a smartphone or tablet via Bluetooth®. With the free Crane Connect app (hereinafter referred to as “app”) you can save and analyse this data on your smartphone or tablet.

The scale can record and transmit physical data for up to eight different users. The data are only visible for the current user and are never visible for other users.

Functions

The scale has the following functions:

- Measurement of body weight (see **fig. D**).
- Calculation of the body mass index “BMI” (see **fig. E**).
- Calculation of body fat percentage “BF” in % (see **fig. F**).
- Calculation of the body water percentage in % (see **fig. G**).
- Calculation of muscle percentage in % (see **fig. H**).
- Calculation of bone mass in kg (see **fig. I**).
- Calculation of the basal metabolic rate “BMR” in kcal (see **fig. J**).
- Calculation of the active metabolic rate “AMR” in kcal.

Measurement method



From a medical standpoint, the analytical results provided by the scale are only of an approximate nature. Only a medical specialist is capable of performing exact measurements of the percentage of body fat, body water, muscle or bone mass using special medical instruments.

The scale uses very low voltage to measure your physical data. The voltage is transmitted through your body, that is, through the different parts of your body. In the process, the current encounters different resistances. Water and muscle tissue have a low resistance making them good conductors. Fat and bone are poor conductors and therefore exhibit a high resistance.

These resistances or impedances are measured and used to calculate the percentages of water, bone and muscle based on individual physical characteristics such as height, age and gender. This method of measurement is known as the “bioelectric impedance analysis” (BIA).

Compatibility

The following smartphones and tablets with Bluetooth® (Bluetooth® 4.0 and higher) are compatible with the scale and the app:

- Apple® iPhone® 4s and more recent versions
- Apple® iPad® 3rd generation and more recent versions
- Apple® iPad mini™ of the 1st generation and more recent versions
- Apple® iPad Air™ and more recent versions
- Smartphones and tablets with Android™ 4.3 and more recent versions

You can find a detailed list of compatible devices on the following website:

www.cranesportsconnect.com/compatibility

Use without app



If you use the scale without the app, the scale is only capable of correctly determining your weight. Without the app all other measurements are performed using standard parameters and will therefore be more or less inaccurate.

Furthermore, the measured data will not be saved on the scale if you use the scale without the app.

In order to calculate your percentage of body fat, body water, muscle mass, bone mass as well as your BMI, AMR and BMR, the scale requires individual parameters such as your gender, height and age. However, it is not possible to enter these parameters on the scale itself, instead this must be done with the app or on the Crane website (see chapter “Creating a user account”).

If these individual parameters are not entered, the resulting measurements may differ considerably from the actual individual values. Thus, weight will be displayed without user recognition if the app is not used. We recommend using the scale in combination with the app.

Setup

Inserting batteries

1. Place the scale on a soft base with the bottom facing up.
2. Open the battery compartment **4** (see **fig. B**).
3. Remove the protective foil from the enclosed batteries **3**.
4. Insert the batteries in the battery compartment. The polarity is correct if the negative poles of the batteries are lined up with the corresponding spring contacts in the battery compartment.

5. Close the battery compartment.
6. Turn the scale over.
The reading “0.0” will appear on the display **1**.
7. If nothing appears on the display, remove the batteries and insert them again.

Setting up the scale

In order for the measurements to be accurate, the scale must be set up on a solid floor or on the enclosed carpet feet:

- Use the carpet feet **2** on carpet floors.
- Place the scale on a solid, level floor.

Affixing the carpet feet

- Place the scale on a soft base with the bottom facing up.
- Stick the carpet feet **2** onto the support feet **6** (see **fig. A**).
You can now use the scale on carpet floors.

Setting the unit of measure for weight

Scales shipped within Europe (except for Great Britain and Ireland) are set to kilograms (kg). Scales shipped to Great Britain, Ireland and the USA are set to pounds (lb). Scales shipped to Australia are set to kilograms (kg). You can use the app to switch the unit of measure.

Resetting the scale memory

You can reset the scale to the factory default by deleting all data:

- Turn the scale on by briefly stepping on it. The display **1** will illuminate in blue and display “0.0 kg”.
- Push and hold the Reset button **5** on the back of the scale for approx. 3 seconds (see **fig. A**).
The reading “dEL” on the display indicates that the data is being deleted.

Installing the app

- Download the free Crane Connect app from the App Store or from the Google Play Store. You can also download the app by scanning one of the following QR codes:

For iOS:



For Android™:



You can also download the app under the following URL:

www.cranesportsconnect.com/downloads

- Install the app on your smartphone or tablet. For this, follow the on-screen instructions.

Creating a user account

The scale has eight user memory slots for storing your individual settings and measurements and those of family members for example. For this purpose, an own user account must be set up for all of those users.

In addition to personal data, the data to be entered include: gender, date of birth and body height. This data serves as parameters for determining relative values such as the BMI.

1. To create a user with the Crane Connect App, follow the instructions for registration step by step.
2. To perform user and product-specific settings, select the app icon “All settings”.

Various icons will now appear on the display.

3. To log on as an existing user, select the icon “User Settings”. Follow the subsequent instructions from the Crane Connect app step by step.

You can also create your user data on the following website:
www.cranesportsconnect.com

Handling

Establishing a Bluetooth® connection

1. Make sure that the Bluetooth® function of your phone or tablet is switched on.
2. Start the app if you have not already done so.
You will be directed to the “Home” menu.
3. Select the app icon “All settings”.
4. Select the app icon “Scale”.
5. You will access the settings for the scale. Here you can determine your level of activity (see chapter “Setting the level of activity”).
6. Turn the scale on by briefly stepping on it.
7. To link the scale to your smartphone or tablet, push “Connect” in the “Pairing” field.
8. The app will now connect to the scale and will prompt you to step on the scale for an initial measurement. Every user must step on the scale barefoot to create a complete scale user record.
9. Go back to the “Home” menu.
10. Select the app icon “Scale” to access the analyses of your measurements.

If you connect the scale to the app and perform a measurement, the data will be automatically uploaded to your user account on the website www.cranesportsconnect.com if you are connected to the Internet.

Your data will be securely saved there and will also be available to you if you lose your smartphone or tablet or replace it with a new one.

As soon as your user account has been connected with the scale via the app, you can also perform measurements without having to connect to the app. The next time you connect the app to the scale, your measurements saved on the scale will also be uploaded to the website if you are connected to the Internet.

The scale has 30 memory slots for each user. Therefore, a maximum of 30 measurements can be saved for each user. "FULL" will then appear on the display.

Creating multiple users in the app

To create additional users for the scale, proceed as follows:

1. Open the app.
2. Select the app icon "All settings".
3. Select the app icon "Scale".
4. Briefly tap on the scale to establish a Bluetooth® connection.
5. Select "Manage user" in the app.
6. Then push "+".
7. Enter the name and data of the new user.
8. Then follow the instruction "Please step on the scale!".

Once the initial measurement has been performed, the creation of a new user is complete.

Setting the level of activity

The level of activity is used to calculate your basal and active metabolic rates in calories.

Realistically consider your lifestyle in the medium to long-term and then select the correct level of activity. Use the app to set one of the following activity levels (see chapter “Establishing a Bluetooth® connection”):

Level of activity	Description
1 Low level of activity	You are not active in your free time or professionally; you spend most of your time sitting or lying down. Examples: Elderly persons or people with physical handicaps.
2 Occasionally active	You engage in a limited amount of activity in your free time or professionally; otherwise you spend most of your time sitting. Examples: Office employees, students, precision mechanics.
3 Moderately active	You are moderately active in your free time and walk or stand when at work. Or you exercise regularly in addition to your sedentary profession. Examples: Assembly line works, craftsmen.
4 Active	You are active both in your free time and at work. Examples: Waiters, salespersons, nursing services.
5 Very active	You engage in strenuous physical activity in your free time and professionally. Examples: Construction workers, farmers, competitive athletes.

Performing a measurement



For ideal, comparable measurement results, follow the basic rules below when performing a measurement.

- Weigh yourself when undressed, on an empty stomach and if possible, always at the same time of day. The best time to weigh yourself is in the morning after you have used the toilet.
- The body fat percentage can only be measured if you are barefoot. Ideally, your feet should be damp, but no cream should have been applied. Completely dry or heavily callused foot soles are not sufficiently conductive and may affect the accuracy of results.
- Your feet, legs, calves and thighs must not touch during measurement.
- When you weigh yourself after getting up, give your body approx. 15 minutes to enable proper distribution of the body water percentage in your body.

Proceed as follows to perform a measurement:

1. Make sure that the scale is on a solid, level floor.
2. Stand on the scale so that the soles of both feet are touching both the front and back measuring electrode **7** (see **fig. C**).
3. Shift your weight so that it is evenly distributed on each foot.
4. Stand still and in an upright position during the measurement.

Your body weight will be displayed in the preset unit of measurement on the bottom right of the display (see **fig. D**).

Then the other values will be measured. The following measurements will appear in sequence on the top left of the display:

- BMI (see **fig. E**),
- “BF” body fat percentage (see **fig. F**),
- Body water percentage (see **fig. G**),
- Muscle percentage (see **fig. H**),
- Bone mass (see **fig. I**),
- Basal metabolic rate “BMR” (see **fig. J**),
- Active metabolic rate “AMR”.

Once the active metabolic rate is shown, the scale will automatically turn off after approx. 4 seconds.

5. Step down from the scale.



If the weight of different users varies by only 2 kg or their body fat percentage by 2 %, the scale will not be able to recognise the user. In this case, the measurements in the app will be saved in the folder “Unknown measurement”.

- Briefly tap on the scale to establish a Bluetooth® connection. Open the folder “Unknown measurement” in the app and manually assign the measurements to the users saved on your smartphone.

Evaluating the measurements



Please keep in mind that all measurements, with the exception of your body weight, are only relevant if you have correctly configured your body parameters (age, body height etc.) in the app.

Restrictions

Please keep in mind that only long-term trends are relevant with respect to significant fluctuations, particularly in terms of your weight. Always consider the measurements in their relation to one another (see chapter “Measurements in relation to one another”).

Certain physical characteristics or impairments may lead the percentage calculations for body water, fat, muscles, bone and bone density to significantly differ from the standard values or return false values. The affected persons include:

- Dialysis patients,
- Persons with a fever or suffering from osteoporosis,
- Persons with illnesses leading to oedema,
- Persons taking cardiovascular medication (e.g. drugs influencing vessels, circulatory or heart medication),
- Persons with considerably shorter or longer leg length,
- Children under 10 years of age.

Body mass index (BMI)

The body mass index is used to distinguish between underweight, normal weight and overweight. You can calculate the value as follows:

Weight in kg/(body height in m)².

The BMI is not very conclusive as an absolute value. It must be associated with the gender and age of the person. See the reference values provided in the following tables.

BMI values for women

Age	Under-weight	Normal weight	Slight overweight	Over-weight
16–24	<19	19–24	25–28	>28
25–34	<20	20–25	26–29	>29
35–44	<21	21–26	27–30	>30
45–54	<22	22–27	28–31	>31
55–64	<23	23–28	29–32	>32
>65	<24	24–29	30–33	>33

BMI values for men

Age	Under-weight	Normal weight	Slight overweight	Over-weight
16	<19	19–24	25–28	>28
17–24	<20	20–25	26–29	>29
25–34	<21	21–26	27–30	>30
35–44	<22	22–27	28–31	>31
45–54	<23	23–28	29–32	>32
55–64	<24	24–29	30–33	>33
>65	<25	25–30	31–34	>34

Body fat percentage

The tables listed here provide reference values for the body fat percentage (%). If you require more accurate information about body fat levels in general or about your own measurements, please speak to your physician.

Compared to the reference values, active athletes tend to have a lower percentage of body fat. Depending on the level of training and type of sport, these values may be below the provided reference values.

An extremely low percentage of body fat may pose a health risk.

Body fat levels for women

Age	Low	Normal	Elevated	Very elevated
10–29	<23	23–34	35–45	>45
30–59	<23	23–34	35–45	>45
60–69	<23	23–34	35–45	>45
>70	<23	23–37	38–45	>45

Body fat levels for men

Age	Low	Normal	Elevated	Very elevated
10–29	<11	11–24	25–35	>35
30–59	<13	13–25	26–35	>35
60–69	<12	12–25	26–35	>35
>70	<12	12–29	30–35	>35

Body water percentage



The measurements performed by the scale do not allow for medically sound conclusions about age-related water retentions. If you are concerned about your body water percentage, ask your physician.

The body water percentage is directly related to the percentage of body fat and muscle. Body fat contains a relatively low amount of water while muscles tend to store significantly more water.

People with a lower percentage of body fat and high muscle percentage may exhibit a body water percentage that exceeds the reference values (such as endurance athletes).

Vice-versa, the body water percentage for people with a high percentage of body fat is often less than reference values.

Generally speaking, a high percentage of body water is ideal.

The following tables provide an overview of reference values for the body water percentage (%).

Body water percentage for women

Age	Low	Normal	Elevated
10–29	<52	52–72	>72
30–49	<40	40–60	>60
>50	<45	45–65	>65

Body water percentage for men

Age	Low	Normal	Elevated
10–29	<55	55–75	>75
30–49	<50	50–70	>70
>50	<48	48–68	>68

Muscle percentage

The following tables provide an overview of reference values for the muscle percentage (%).

Muscle percentage for women

Age	Low	Normal	Elevated
10–29	<35	35–45	>45
30–59	<28	28–40	>40
60–69	<23	23–35	>35
>70	<23	23–30	>30

Muscle percentage for men

Age	Low	Normal	Elevated
10–29	<40	40–50	>50
30–59	<33	33–45	>45
60–69	<32	32–40	>40
>70	<30	30–35	>35

Bone mass



The scale measures the weight of all parts of your bones in pounds. This is not the same thing as calcium concentration or bone density. Only a medical specialist can measure the calcium concentration and bone density with a special medical device. The bone mass therefore does not provide any information about changes to bones, bone hardness or diseases such as osteoporosis.

Our skeleton changes as we age. As we grow up, our bone mass increases quickly and peaks between the age of 30 and 40. Afterwards, it starts to slowly decline.

Bone mass varies according to gender, height, age and weight and can only be influenced to a limited extent. As a result, there are no universally-applicable reference values.

You can counteract the age-related loss of bone mass associated with ageing with proper nutrition and physical activity. At the same time, be sure that you are getting a sufficient amount of vitamin D and calcium. You can strengthen your skeleton by engaging in athletic activity to strengthen your muscles.

Basal metabolic rate (BMR)

The basal metabolic rate, BMR, refers to the amount of energy your body requires on a daily basis when fully at rest in order to maintain its basic functions. Therefore, you must consume at least this amount of energy through your diet to avoid any harm to your health.

Body height, age and weight are the primary factors that affect the basal metabolic rate. The scale calculates this value in kilocalories per day (kcal/24h) using the Harris-Benedict formula.

Active metabolic rate (AMR)

The active metabolic rate, AMR, refers to the amount of energy your body requires on a daily basis during activity. The scale calculates this amount in kilocalories per day (kcal/24h).

To maintain your weight, you must consume the amount of energy that corresponds to your active metabolic rate through your diet. If you consume less energy than the calculated active metabolic rate, you will lose weight.

On the other hand, your weight will increase if you consume more energy than your active metabolic rate. However, if you do not increase the amount of daily physical activity, increasing the amount of energy consumed will only cause the percentage of body fat to rise.

The active metabolic rate is primarily affected by the personal extent of activity. The scale uses five levels of activity as calculation parameters.

Please obtain details on the degrees of activity from the chapter “Setting the level of activity”.

Measurements in relation to one another



Adding up the measurements for water, fat and muscle percentage does not make sense because a portion of the body water is stored in muscle.

In general, only long-term changes to measurements are really conclusive. The individual results must also be considered in relation to one another. This leads to three fundamental aspects:

- Change to the total weight,
- Change to body fat, body water and muscle percentage,
- Period during which these changes occur.

The periods are divided into:

Short-term	Changes within days
Medium-term	Changes within weeks
Long-term	Changes within months

Short-term fluctuations in weight are primarily attributed to changes in the water percentage as the percentage of fat and muscle only change over the medium or long-term.

Short-term weight loss with a simultaneous increase in the percentage of body fat are also an indication for the sole loss of water. This could be due to diets or workouts that target rapid weight loss without sufficient compensation of water loss.

If possible, balance diets with physical activity such as fitness or strength training to increase your muscle percentage.

A medium-term increase in weight with a constant or declining percentage of body fat indicates an increase in muscle mass.

A decrease in weight and body fat while the muscle percentage remains the same or increases is indicative of an effective diet or workout.

Cleaning and maintenance

NOTICE!

Risk of damage to property!

If you clean the scale improperly, you could damage it.

- Do not use any aggressive cleaners or solvents.
- Do not use any brushes with metal or nylon bristles, sharp or metallic cleaning utensils such as knives, hard scrapers or similar.
- Do not put the scale in the dishwasher. It would be destroyed as a result.
- Use a cloth moistened with water for cleaning. If necessary, you can use a small amount of detergent or a mild soapy solution.
- After cleaning, use a soft cloth to dry the scale.

Changing the batteries

If you stand on the scale and “Lo” appears on the display instead of the measurements, the batteries are no longer supplying sufficient power.

If you stand on the scale and nothing appears on the display, the batteries are empty. To change the batteries, proceed as follows:

1. Place the scale on a soft base with the bottom facing up.
2. Open the battery compartment **4** (see **fig. B**).
3. Take the batteries **3** out of the battery compartment.
4. Insert new batteries in the battery compartment. Use batteries of the same type.
The polarity is correct if the negative poles of the batteries are lined up with the corresponding spring contacts in the battery compartment.
5. Close the battery compartment.
6. Turn the scale over.
The reading “0.0” will appear on the display **1**.
7. If nothing appears on the display, remove the batteries and insert them again.

Storage

If you do not use the scale for a prolonged period of time, please observe the following notes:

- Take the batteries **3** out of the battery compartment **4**.
- Do not store the scale near heat sources.
- Do not place any heavy objects on the scale if you do not use the scale.

Troubleshooting

If a malfunction occurs, first check the points below before you send the scale in to be repaired.

Problem	Causes and solutions
The display is blank.	<p>The batteries were not inserted correctly.</p> <ul style="list-style-type: none"> - Remove the batteries and insert them again. Make sure the polarity is correct.
	<p>Batteries are empty.</p> <ul style="list-style-type: none"> - Replace the empty batteries with new ones.
“Lo” appears on the display instead of the measurements and the scale immediately turns off.	<p>The batteries no longer supply a sufficient amount of power.</p> <ul style="list-style-type: none"> - Replace the batteries with new ones.
“Err” appears on the display instead of the measurements.	<p>The upper limit of the measurement range (180 kg) has been exceeded.</p> <ul style="list-style-type: none"> - Do not exceed the scale’s carrying capacity of 180 kg.
	<p>You failed to stand still during the measuring process or to evenly distribute your body weight to both feet.</p> <ul style="list-style-type: none"> - Stand still while the measurements are being performed and evenly distribute your weight to both feet.

Problem	Causes and solutions
<p>Only the weight is shown.</p> <hr/> <p>The percentage of fat is outside the measurement range (< 5 % or > 50 %).</p>	<p>You were not barefoot during the measurement, the soles of your feet are too dry or you have too much callused skin on the soles of your feet.</p> <ul style="list-style-type: none"> - Repeat the measurement barefoot. - If necessary, slightly moisten the soles of your feet. - Remove any callused skin from the soles of your feet.
<p>The scale was not at zero when the weighing process was initiated.</p>	<p>The scale did not adjust properly.</p> <ul style="list-style-type: none"> - Wait until the scale turns off on its own. - Step on the scale again and wait until "0.0" appears on the display. - Repeat the measurement.
<p>No connection is established between your smartphone or tablet and the scale even after approx. 180 seconds.</p>	<p>The Bluetooth® function of your smartphone or tablet is switched off.</p> <ul style="list-style-type: none"> - Switch the Bluetooth® function of your smartphone or tablet on. <p>The scale's Bluetooth® receiver is not working properly.</p> <ul style="list-style-type: none"> - Take the batteries out of the battery compartment. - Put the batteries back in. - Switch the Bluetooth® function of your smartphone or tablet off and back on.

Problem	Causes and solutions
No connection is established between your smartphone or tablet and the scale even after approx. 180 seconds.	Your smartphone or tablet is not working properly. <ul style="list-style-type: none"> - Switch off your smartphone or tablet off completely and then back on.
	The app was not successfully installed on your smartphone or tablet. <ul style="list-style-type: none"> - Reinstall the app and log in with your user data.
Not all measurements saved are transmitted.	You performed more than 30 measurements without connecting to the app. The scale can save a total of 30 measurements after a user has been created. "FULL" will then appear on the display. <ul style="list-style-type: none"> - Connect the scale with the app on a regular basis to prevent losing measurements.

Use the FAQs (frequently asked questions) on the following website as an additional help for your scale:
www.cranesportsconnect.com/faq.php

If the measures described above have not resolved the problem, please contact our service team. Use the information provided below and also consider the warranty conditions.

CUSTOMER *Service*



Please note: For organizational reasons, we **cannot accept any unannounced packages** not prepaid.

Please **use our service home page first** or contact us through the **e-mail address** below or the toll-free **service hotline.**

Please have the **model no.** ready, which can be found either **on the back or on the bottom** of the product.



www.cranesportsconnect.com



service@cranesportsconnect.com



Toll-free service hotline
1800 13 1579

Technical data

Type:	AA7-CDSC-3
Article number:	94018
Power supply:	Batteries, 3 x 1.5 V DC, type LR03/R03/AAA
Materials	
• Scale surface:	Safety glass, 6 mm thick
• Electrodes:	non-rusting steel
• Housing:	ABS plastic
Dimensions (W x D x H):	30 × 30 × 2.3 cm
Upper limit of the measurement range:	max. 180 kg/396 lb/28 st
Lower limit of the measurement range:	3 kg/6.6 lb/0 st (≈ 6.6 lb)
Display accuracy	
• Weight:	0.1 kg/0.2 lb/0.2 lb
• Bone mass:	0.1 kg/0.2 lb/0.2 lb
• Body fat percentage:	0.1 %
• Body water percentage:	0.1 %
• Muscle percentage:	0.1 %
• Calorie requirement:	1 kcal

Disposal

Disposing of the packaging

Dispose of the packaging separated into single type materials. Dispose of cardboard and carton as waste paper and foils via the recyclable material collection service.

Disposing of old appliances

Should the scale no longer be capable of being used at some point in time, dispose of it in accordance with the regulations in force in your state or country.

Batteries and rechargeable batteries must not be disposed of with household waste!

As the end user you are required by law to bring all batteries and rechargeable batteries, regardless whether they contain harmful substances* or not, to a collection point run by the communal authority or borough or to a retailer, so that they can be disposed of in an environmentally friendly manner. Turn in the batteries and rechargeable batteries at your collection point in a discharged state only!

* labelled with: Cd = cadmium, Hg = mercury, Pb = lead



Bluetooth® Smart digital scale

Warranty Details

The product is guaranteed to be free from defects in workmanship and parts for a period of 36 months from the date of purchase. Defects that occur within this warranty period, under normal use and care, will be repaired, replaced or refunded at our discretion. The benefits conferred by this warranty are in addition to all rights and remedies in respect of the product that the consumer has under the Competition and Consumer Act 2010 and similar state and territory laws.

Our goods come with guarantees that cannot be excluded under the Australian Consumer Law. You are entitled to a replacement or refund for a major failure and for compensation for any other reasonably foreseeable loss or damage. You are also entitled to have the goods repaired or replaced if the goods fail to be of acceptable quality and the failure does not amount to a major failure.

AFTER SALES SUPPORT

 (AUS) 1800 13 1579  www.cranesportsconnect.com
Free hotline

3
YEARS
WARRANTY



Bluetooth® Smart digital scale

Repair and Refurbished Goods or Parts Notice

Unfortunately, from time to time, faulty products are manufactured which need to be returned to the Supplier for repair.

Please be aware that if your product is capable of retaining user-generated data (such as files stored on a computer hard drive, telephone numbers stored on a mobile telephone, songs stored on a portable media player, games saved on a games console or files stored on a USB memory stick) during the process of repair, some or all of your stored data may be lost.

We recommend you save this data elsewhere prior to sending the product for repair.

You should also be aware that rather than repairing goods, we may replace them with refurbished goods of the same type or use refurbished parts in the repair process.

Please be assured though, refurbished parts or replacements are only used where they meet ALDI's stringent quality specifications.

If at any time you feel your repair is being handled unsatisfactorily, you may escalate your complaint. Please telephone us on 1800 13 1579 or write to us at:

Krippel-Watches

Reply Paid 85139, Level 29, Chifley Tower
2 Chifley Square, Sydney NSW 2000/AUSTRALIA
1800 13 1579 (08.30 am - 06.00 pm)
service@cranesportsconnect.com

AFTER SALES SUPPORT

  1800 13 1579  www.cranesportsconnect.com
Free hotline

3
YEARS
WARRANTY

ALDI guarantees that our exclusive brand products are developed to our stringent quality specifications. If you are not entirely satisfied with this product, please return it to the nearest ALDI store within 60 days from the date of purchase, for a full refund or replacement, or take advantage of our after sales support by calling the supplier's Customer Service Hotline.



Made in China

Crane® is a registered trademark of ALDI Stores

DISTRIBUTED BY:

ALDI STORES

1 SARGENTS ROAD

MINCHINBURY NSW 2770

www.aldi.com.au

AFTER SALES SUPPORT

94018 

  1800 13 1579

 www.cranesportsconnect.com

MODEL:
AA7-CDSC-3

06/2017

3
YEARS
WARRANTY