



User Manual



Wireless Activity Wristband



Product
Info



www.aldi.com.au

+ VIDEO

Contents

Overview	4	Sleep mode	27
Use	5	Alarm function	28
Scope of delivery/ device parts	6	Compatible Bluetooth® devices	29
QR code	7	Watertightness.....	30
General information	9	Operation	32
Reading and storing the instruction manual....	9	Charging the rechargeable battery.....	32
Explanation of symbols	10	Inserting the display module	34
Safety	13	Putting on the wristband/clip.....	35
Proper use	13	Activating the display module	36
Safety notes	14	Switching the display module off.....	36
Checking the wristband/ Product contents	18	Setting the time and time mode.....	37
Functions	19	Downloading and installing the Crane Connect app.....	37
Data storage	21	Connecting the wristband with the Crane Connect app.....	40
Modes	21	Using the wristband without the Crane Connect app.....	42
Time mode	23	Activating sleep mode.....	43
Step counter mode	24	Deactivating sleep mode	44
Distance mode	25		
Calorie mode	26		
Activity Time mode	27		

Care and maintenance	45
Cleaning the wristband.....	45
Storing the wristband.....	46
Troubleshooting	47
Declaration of conformity	49
Technical data	50
Disposal	51
Disposing of the packaging	51
Disposing of the wristband	51
Warranty	53
Warranty Certificate.....	53
Repair and Refurbished Goods or Parts Notice	55
Warranty Certificate.....	57
Customer Service	61

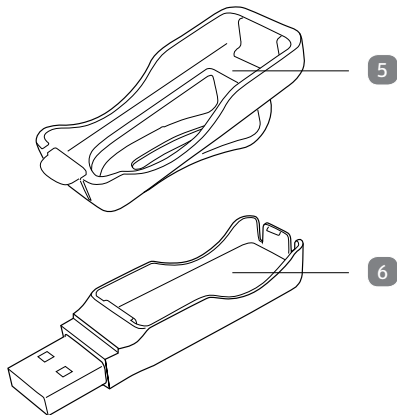
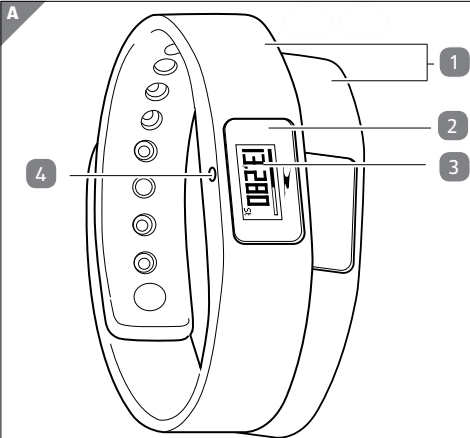

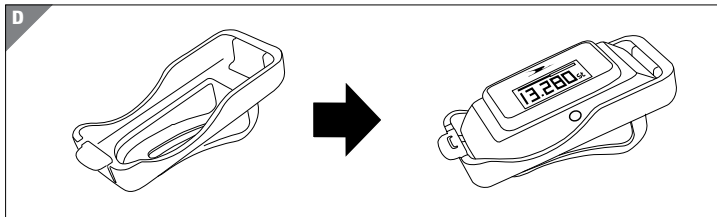
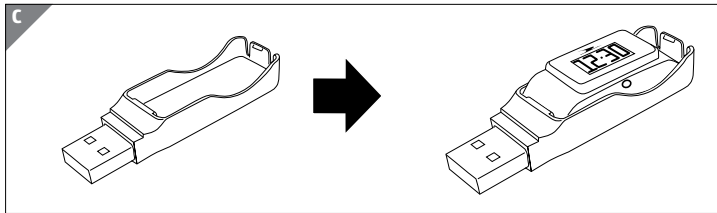
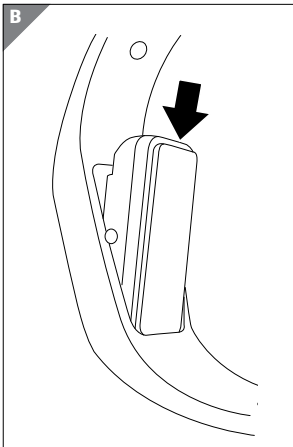

Scope of delivery/ device parts

- 1 Band, 2x
- 2 Display module, removable
- 3 Display (OLED display)
- 4 Menu button
- 5 Clip
- 6 USB charger

QR codes get you results fast and without the hassle

Regardless whether you need product information, spare parts or accessories, are looking for information about manufacturer warranties or service points or would like to watch a convenient instructional video, our QR codes will help you to easily get the information you are looking for.

What are QR codes?

QR codes (QR= Quick Response) are graphical codes that can be read with a smartphone camera and, for example, contain a link to a website or contact data.

Your benefit: No need to type in bothersome web addresses or contact data!

How it works:

To scan the QR code, all you need is a smartphone with a QR code reader installed on it and an Internet connection*. Generally, you can find a QR code reader in the App Store for your smartphone.

Try now

Just scan the QR code below with your smartphone to learn more about the Aldi product you purchased.*

* When running the QR code reader, costs for the Internet connection may be incurred depending on your rate.



General information

Reading and storing the instruction manual



This instruction manual accompanies this Wireless Activity Wristband. It contains important information about operation and care. For improved readability, the Wireless Activity Wristband will only be referred to as wristband below.

Before using the wristband, read the instruction manual carefully. This particularly applies for the safety notes. Non-observance of this instruction manual may cause damage to the wristband.



The instruction manual is based on the standards and rules in force in the European Union. When abroad, you must also observe country-specific guidelines and laws.

Store the instruction manual for future use.

Make sure to include this instruction manual when passing the wristband on to third parties.

Explanation of symbols

The following symbols and signal words are used in this instruction manual, on the wristband or on the packaging.



WARNING! This signal word designates a hazard with moderate degree of risk which may lead to death or severe injury if not avoided.



CAUTION! This signal key word indicates a hazard with low risk that, if not avoided, may result in minor or moderate injury.



NOTICE! This signal word warns against possible damage to property or provides you with useful additional information.



Declaration of conformity (see chapter “Declaration of conformity”): Products marked with this symbol fulfil the requirements of the R&TTE 1999/5/CE and RoHS 2011/65/EU directives.

Google Play™ and Android™ are trademarks of Google Inc.

Apple, the Apple logo, iPad, and iPhone are trademarks of Apple Inc., registered in the U.S. and other countries. App Store is a service mark of Apple Inc.

The Bluetooth® word mark and logos are registered trademarks of Bluetooth SIG, Inc. and any use of such marks by Krippel-Watches is under license.

Other trademarks and trade names are those of their respective owners.

Safety

Proper use

The wristband is exclusively designed for measuring your activity and sleeping habits. It is designed for collecting data for analysis with the Crane Connect app. You can use this data to help you reach your goals in terms of fitness, level of activity and sleep.

The wristband is only intended for private use and is not suitable for commercial, therapeutic or medical applications. It is not a children's toy or a medical device.

Only use the wristband as described in this instruction manual.

Any other use is deemed improper and may result in damage to property or even personal injury.

The manufacturer or vendor accepts no liability for damage caused by improper or incorrect use.

Safety notes



WARNING!

Risk of swallowing and choking!

If small children or animals swallow the display module, they could choke on it.

- Keep the display module away from children and animals.
- If children or animals have swallowed the display module, immediately contact a physician.



WARNING!

Risk of injury!

Incorrect operation may result in severe injury.

- If you have a pacemaker, be absolutely sure to ask your physician before using the wristband for the first time.

**WARNING!****Danger of explosion!**

Rechargeable batteries may explode if they are excessively heated up.

- Do not heat up the display module.
- Keep the wristband away from hot surfaces.
- Do not throw the display module in an open fire.
- Protect the display module from direct sunlight.
- Do not charge the rechargeable battery in the direct vicinity of hot surfaces or objects.

**WARNING!****Risk of chemical burns from battery acid!**

Leaking battery acid may lead to chemical burns.

- Do not allow battery acid to come into contact with skin, eyes or mucus membranes.
- In the event of contact with battery acid, immediately flush the applicable areas with plenty of clean water and consult a physician.

**CAUTION!****Risk of injury!**

Incorrect operation may result in injury.

- Do not use the wristband if it exhibits visible damages.

- Do not open the housing of the display module and have qualified professionals perform repairs. Liability and warranty claims are waived in the event of repairs performed by the user or incorrect use.

**NOTICE!****Risk of damage!**

Improper handling of the wristband may damage it.

- Keep sharp objects away from the wristband.
- Store the wristband so that there is no risk of it falling into a tub or sink.
- Do not take the rechargeable battery out of the display module; it is firmly integrated in it and cannot be replaced.
- Only use the USB charger, which is connected to a computer or external power supply, to charge the empty rechargeable battery.

- You can use the wristband at ambient temperatures between -10 °C and +60° C.
- Do not submerge the display module in water or other liquids.
- Do not place any objects on the wristband and do not apply pressure to the display.

**NOTICE!**

Avoid strong magnetic fields (e.g. transformers). Otherwise, this may cause fluctuations in the transmission of the data measured.

Checking the wristband/ Product contents

1. Take the wristband out of the packaging.
2. Remove the protective foil from the display **3**.

3. Check to make sure that the delivery is complete (see **fig. A**).
4. Check whether the individual parts exhibit damages. If this is the case, do not use the wristband. Contact the manufacturer at the service address specified on the warranty card.

Functions

To reach your goals in terms of fitness, level of activity and sleep, you can use the wristband to record your level of activity and sleeping habits. In the steps, distance and calories modes, a progress bar indicates how close you are to reaching your goals. Once you reach your goal, the corresponding progress bar will blink and a sound will be emitted. You can set your goals with the Crane Connect app. In order for you to determine the best target value, the Crane Connect app will also specify the individual limits.

The wristband has the following functions:

- Time
- Steps
- Distance
- Calories
- Activity time
- Progress check
- Setting of daily goals (steps, distance and calories only in conjunction with the Crane Connect app)
- Recording of sleep cycles with the Crane Connect app (waking up phase, light sleep phase, deep sleep phase)
- Alarm function







The Crane Connect app provides a detailed view for each target value. It provides you with an itemised view of the daily recorded data. The detail view for sleep mode even offers the possibility of displaying the sleep cycles (waking up, light sleep and deep sleep cycle).

Data storage

The wristband saves all measured data for seven days. From the 8th to 30th day, only the daily totals will be saved. If during this time you do not connect the wristband with the Crane Connect app, the first record will be overwritten by the last one on the 31st day.

Modes

The wristband has six different modes you can choose from:

Mode	Symbol
• Time mode	
• Step counter mode	
• Distance mode	
• Calorie mode	
• Activity time mode	
• Sleep mode	

Time mode

Time mode is the first mode that appears on the display module. You can switch to the other modes from this mode.

- To switch the mode, push the menu button  from the time mode:
 - To switch to step counter mode, push the menu button once.
 - To switch to distance mode, push the menu button twice.
 - To switch to calorie mode, push the menu button three times.
 - To switch to activity time mode, push the menu button four times.
 - To switch to sleep mode, push the menu button five times.

The display will go out automatically after three seconds. To switch it back on, push the menu button again.

Step counter mode

The wristband counts the steps you cover in a day. The more steps you cover during one day, the longer the progress bar at the top of the display will become. It shows you how close you are to reaching your target number of steps. Once you have reached your target number of steps, the progress bar will blink and an acoustic signal will be emitted. By factory default, a daily target of 10,000 steps has been set. You can use the Crane Connect app to change this setting.

At 12 midnight, the step counter will automatically reset to zero.



NOTICE!

If the wristband is in sleep mode, the wristband will not count the steps you cover.

Distance mode

The wristband determines the distance you cover in one day in km. The calculation is based on the steps counted and your individual data (step length, height, gender), which the wristband obtains from the Crane Connect app.

The greater the distance you cover during one day, the longer the progress bar at the top of the display will become. It indicates current progress with respect to your target distance. Once you have reached your target distance, the progress bar will blink and an acoustic signal will be emitted. By factory default, a daily target of 6 km has been set. You can use the Crane Connect app to change this setting.

At 12 midnight, the distance will automatically reset to zero.

**NOTICE!**

If the wristband is in sleep mode, the wristband will not measure the distance you cover.

Calorie mode

The wristband calculates the calories you burn in a day. The calculation is based on your level of activity and your individual data (height, age, gender, weight, duration of sleep, etc.), which the wristband obtains from the Crane Connect app. The more calories you burn during one day, the longer the progress bar at the top of the display will become. It shows you how close you are to reaching your daily target. Once you have burned the desired number of calories, the progress bar will blink and an acoustic signal will be emitted.

By factory default, a daily target of 3,000 calories has been set. You can use the Crane Connect app to change this setting. You can determine the number of calories burned directly on your wristband or via the Crane Connect app.

At 12 midnight, the number of calories is automatically reset to zero. Please keep in mind that calories are also burned while you sleep and the number of calories burned is recorded from 12 midnight on.

Activity Time mode

The wristband measures the amount of time you are active in hours and minutes. At 12 midnight, the activity time is automatically reset to zero.

Sleep mode zzz

The wristband measures your sleep in hours and minutes. The wristband does not

automatically recognise that you are sleeping – you have to activate sleep mode for this (see chapter “Activating sleep mode”). You can also wear the wristband when you go to bed.

The wristband records the duration and quality of your sleep; the Crane Connect app provides you with an analysis of your sleep cycles and quality.

Alarm function

You can use the Crane Connect app to set an alarm function. Overall, you can set up to three alarms. When an alarm activates, an acoustic signal will be emitted for approx. 30 seconds; the alarm symbol (🔔) and current time will be shown in alternation on the display.

- Push the menu button to switch off the alarm .

Compatible Bluetooth® devices

The following devices with Bluetooth® Smart Ready (Bluetooth® 4.0) are compatible with the wristband and the Crane Connect app:

- Apple® iPhone® 4s and more recent versions
- Apple® iPad® 3rd generation and more recent versions
- Apple® iPad mini™ of the 1st generation and more recent versions
- Apple® iPad Air™ and more recent versions
- Smartphones and tablets with Android™ 4.3 and more recent versions







NOTICE!

You can find a complete list of supported devices online at www.cranesportsconnect.com/compatibility.

Watertightness

The following table will tell you in what situation the wristband is waterproof up to 30 m.

	Situation	Watertight to 30 m
	Rain splashes	Yes.
	Washing hands (splash water)	Yes, but do not immerse the wristband in water.
	Showering	No.
	Bathing/swimming	No.



	Situation	Watertight to 30 m
	Water sports (e.g. diving)	No.



*The specification of meters refers to the air overpressure used in connection with the watertightness test for the wristband in accordance with DIN 8310.

Operation

Charging the rechargeable battery

The charge status of the rechargeable battery is shown on the display. The charge status is indicated using the following symbols:

Symbol	Charge status
	78 – 100 %
	56 – 77 %

Symbol	Charge status
	33 – 55 %
	11 – 32 %
	0 – 10 %

- Push the menu button to determine whether the rechargeable battery is completely empty .

The symbol  will appear on the display for three seconds.

To charge the rechargeable battery:

1. Take the display module **2** out of the band **1** or the clip **5** (see **fig. B**).
2. Insert the display module in the USB charger **6** (see **fig. C**).
3. Connect the USB charger e.g. to a computer.

**NOTICE!**

You can also use a mains adapter with a USB port to charge it (not included in the product contents).

Inserting the display module

- Push the display module **2** into the band **1** or the clip **5** so that it is secure and unable to fall out (see **fig. D**).

You have successfully assembled the wristband and can now use it.

Putting on the wristband/clip



NOTICE!

We recommend that you do not wear the wristband on your dominant hand.

- Put the desired band **1** with the display module **2** around your wrist and fasten the band.

The band should not be fitted too tightly, but also not too loosely around your wrist. It must not cause you any pain, but it should be secure enough so as to prevent loss.

- Or fasten the clip **5** with the display module **2** e.g. on a trouser pocket, shirt, bra or belt.

Activating the display module





NOTICE!

Fully charge the wristband before using it for the first time (see chapter “Charging the rechargeable battery”).

- To activate the display module, hold the menu button  down for two seconds and for four seconds if you are switching the display module on for the first time. “How are you?” will appear on the display.

Switching the display module off

1. In time mode, push the menu button for two seconds.
The messages  “Pair?” and “Off?” will appear on the display.
2. After “Off?” has appeared on the display, push the menu button  to switch the

display module off.

Setting the time and time mode

Time mode indicates the current time. This is automatically adopted by the Crane Connect app. In the app, you can set the time mode to 24 h or 12 h.

Downloading and installing the Crane Connect app

If you would like to use the wristband in combination with the Crane Connect app, you must download the Crane Connect app and install it on your smartphone for example.

- Download the free Crane Connect app from the App Store, from the Google Play Store at www.cranesportsconnect.com/downloads or via the following QR code.

QR code for Android:



QR code for iOS:



- Install the Crane Connect app on your smartphone.
Follow the step-by-step instructions for this.

Creating a user

To create a user with the Crane Connect app , proceed as follows:

1. Open the Crane Connect app.

You can now choose from the following items in the “Home” menu:

- Activity Tracker
 - Tutorials
 - All Settings
 - FAQ
2. To perform user and product-specific settings, select the icon “All Settings”.
Various icons will now appear on the display.
 3. To create a new user or log on with an existing user, select the icon “User Settings”.
Follow the subsequent instructions from the Crane Connect app step by step.

**NOTICE!**

You can also create new users on the website
www.cranesportsconnect.com.

Connecting the wristband with the Crane Connect app





NOTICE!

Make sure that the Bluetooth® function on your smartphone has been activated.

1. Once the user settings are complete, return to the “All Settings” menu.
2. Select the icon “Activity Tracker”.
You now edit additional settings of the wristband.
3. To connect the wristband with your smartphone, select the item “Connect” in the “Pairing” field.
4. Select “Pair?” on the display module **2** by pushing and holding the menu button **4** down for approx. two seconds in time mode.

The battery symbol followed by “Pair?” will appear on the display **3**.

5. Push the menu button again.

“Pairing...” will appear for approx. 20 seconds on the display. During this time, the wristband will connect with your smartphone. Once the connection has been successfully established, the symbol  will appear on the display. If the connection cannot be created, the symbol  will appear on the display.

6. Once you have successfully connected the wristband with your smartphone, return to the “Home” menu.

From there, you can access all analyses of the measured data via the icon “Activity Tracker”.

As soon as you have connected the wristband with the Crane Connect app, all recorded data will be transferred to it.

**NOTICE!**

If the Internet connection on your smartphone is active, the Crane Connect app will automatically upload all data measured to the website www.cranesportsconnect.com for permanent storage.

Using the wristband without the Crane Connect app

You can also use the wristband without the Crane Connect app. In the process, keep in mind that the personal data of an average user is used to determine the calories burned and the distance. As a result, your actual results may differ from the determined results.

Without the Crane Connect app, your data can only be saved for the current day. The data can only be permanently stored and displayed once the data has been transferred and uploaded to the website while you are connected to the Internet.

Without the Crane Connect app, you cannot adapt the factory default targets to your individual targets. The following values have been set by factory default:

- Target steps: 10,000 steps
- Target distance: 6 km
- Calorie consumption: 3,000 calories

Activating sleep mode

Wear the wristband when you go to bed and activate sleep mode as follows:

1. In sleep mode, hold the menu button  down for approx. two seconds.

The message “Sleep?” will appear on the display.



2. Push the menu button again to activate sleep mode.

The icon  will appear on the display. Sleep mode has now been activated. The duration and quality of your sleep will now be recorded. You can view the data collected via the Crane Connect app.

**NOTICE!**

The current time will appear on the display if you push the menu button now.

Deactivating sleep mode

1. After waking up, hold the menu button  down for approx. two seconds. The message “Wake?” will appear on the display.
2. Push the menu button to end sleep mode.
 and the duration of your last sleep will appear on the display.

Care and maintenance

Cleaning the wristband



NOTICE!

Risk of damage!

Improper handling of the wristband may result in damage.

- Do not use any aggressive cleaners, brushes with metal or nylon bristles, sharp or metallic cleaning utensils such as knives, hard scrapers and the like. They could damage the surfaces.
- Do not submerge the display module in water or other liquids.
- Use a soft brush, a small amount of water and a mild soap to clean the band **1**.

- Wipe the display module **2** off with a soft, damp (if necessary), lint-free cloth.
- Let the band and display module air dry completely before storing them.

Storing the wristband



NOTICE!

Risk of damage!

Improper handling of the wristband may damage it.

- Store the wristband in a suitable location between -20 °C and +70 °C.
 - Keep the wristband away from direct sunlight.
- Store the wristband in a clean, dry area.

Troubleshooting

Use the following information and our FAQs (frequently asked questions) on our website to rectify any faults:

www.cranesportsconnect.com/faq

Fault	Solution
Not all of the data measured were transferred.	If you have not synchronised with the Crane Connect app in the last 30 days, the data measured prior to then will be overwritten.

Fault	Solution
The wristband and your smartphone will not connect.	– Switch Bluetooth® off on your smartphone and then back on.
	– Then restart the connection process with your wristband.
	– Switch your smartphone off and then back on.
	– Activate the visibility of your smartphone in the Bluetooth® menu.
	– Reinstall the Crane Connect app on your smartphone.

**NOTICE!**

- Before you complain about the wristband, please check whether the rechargeable battery is empty and recharge it if necessary.

Declaration of conformity

Krippel-Watches hereby declares that the Wireless Activity Wristband (model no. AA5-CDAT-2A/2B/2C/2D) complies with the fundamental requirements and other applicable provisions of the R&TTE 1999/5/EC and RoHS 2011/65/EU directives.

You can access the complete text for the declaration of conformity on our website: www.produktservice.info (EAN code: 20020484).

Technical data

Model no.:	AA5-CDAT-2A/2B/2C/2D
Article number:	92072
Operating temperature:	-10 °C to +60 °C
Battery:	Rechargeable battery
Length of the wristband:	approx. 27 cm

Disposal

Disposing of the packaging

Dispose of the packaging separated into single type materials. Dispose of cardboard and carton as waste paper and foils via the recyclable material collection service.

Disposing of the wristband

Dispose of the wristband in accordance with the applicable laws and regulations for your country.

Batteries and rechargeable batteries may not be disposed of with household waste!

As the end user you are required by law to bring all batteries and rechargeable batteries, regardless whether they contain harmful substances* or not, to a collection point run by the communal authority or borough or to a retailer, so that they can be disposed of in an environmentally friendly manner. Turn in the battery at your collection point in a discharged state only.

* labelled with: Cd = cadmium, Hg = mercury, Pb = lead



Warranty Certificate

Wireless Activity Wristband

Crane

Product code: 92072

Model: AA5-CDAT-2A/2B/2C/2D

Name

Address

Email

Daytime tel. no.

Date of purchase

Serial number



We recommend that you attach a photocopy of your receipt, showing the date of purchase, to this Warranty certificate and **keep for your reference**. Please do not send to the address below.

In the event of a product fault, please call the Customer Service hotline. Please ensure that you have the product details (as shown on this card) at hand so that we are able to respond as quickly and efficiently as possible.

KRIPPL-WATCHES
Reply Paid 85139
Level 29, Chifley Tower
2 Chifley Square
Sydney NSW 2000
AUSTRALIA

3
YEARS
WARRANTY

AFTER SALES SUPPORT

 1800 13 1579 (toll-free service hotline)

 service@produktservice.info

MODEL: AA5-CDAT-2A/2B/2C/2D

PRODUCT CODE: 92072

03/2015





Wireless Activity Wristband

Repair and Refurbished Goods or Parts Notice

Unfortunately, from time to time, faulty products are manufactured which need to be returned to the Supplier for repair.

Please be aware that if your product is capable of retaining user-generated data (such as files stored on a computer hard drive, telephone numbers stored on a mobile telephone, songs stored on a portable media player, games saved on a games console or files stored on a USB memory stick) during the process of repair, some or all of your stored data may be lost.

We recommend you save this data elsewhere prior to sending the product for repair.

You should also be aware that rather than repairing goods, we may replace them with refurbished goods of the same type of use refurbished parts in the repair process.

Please be assured though, refurbished parts or replacements are only used where they meet ALDI's stringent quality specifications.

If at any time you feel your repair is being handled unsatisfactorily, you may escalate your complaint. Please telephone us on 1800 13 1579 or write to us at:

KRIPPL-WATCHES

Reply Paid 85139, Level 29, Chifley Tower
2 Chifley Square, Sydney NSW 2000

AUSTRALIA



AFTER SALES SUPPORT

 1800 13 1579 (toll-free service hotline)

 service@produktservice.info

MODEL: AA5-CDAT-2A/2B/2C/2D

PRODUCT CODE: 92072

03/2015



WARRANTY CERTIFICATE

Congratulations! You have made an excellent choice of this quality product. Our commitment to quality also includes our service. Should you, contrary to expectations, experience defects due to manufacturing faults, ALDI will provide you with a warranty against defects as follows:

Warranty

The product is guaranteed to be free from defects in workmanship and parts for a period of three years from the date of purchase. Defects that occur within this warranty period, under normal use and care, will be repaired, replaced or refunded at our discretion. The benefits conferred by this warranty are in addition to all rights and remedies in respect of the product that the consumer has under the Competition and Consumer Act 2010 and similar state and territory laws.

Our goods come with guarantees that cannot be excluded under the Australian Consumer Law.

You are entitled to a replacement or refund for a major failure and for compensation for any other reasonably foreseeable loss or damage. You are also entitled to have the goods repaired or replaced if the goods fail to be of acceptable quality and the failure does not amount to a major failure.

Proof of Purchase

This warranty is valid for the original purchase and is not transferable. Please keep your purchase docket, tax invoice or receipt as the best proof of purchase, and as proof of date on which the purchase was made.

Extent of Warranty

This warranty is limited to defects in workmanship or parts. All defective products or parts will be repaired or replaced. This warranty does not cover batteries or any other consumable items.

Normal Wear and Tear

This warranty does not cover normal wear and tear to the products or parts.

Exclusions

This warranty does not cover:

- Any defects caused by an accident, misuse, abuse, improper installation or operation, lack of reasonable care, unauthorised modification, loss of parts, tampering or attempted repair by a person not authorised by the distributor.
- Any product that has not been installed, operated or maintained in accordance with the manufacturer's operating instructions provided with the product.

- Any product that has been used for purposes other than domestic use.
- Any damage caused by improper power input or improper cable connection.

To Make a Claim

This warranty against defects is provided by ALDI Stores, Locked Bag 56, St. Marys Delivery Centre, NSW 2760, Phone (02) 9675 9000. If a defect in the goods appears within three years (the identified period on the packaging), you are entitled to claim a warranty, please contact or send all warranty claims to:

KRIPPL-WATCHES
Reply Paid 85139
Level 29, Chifley Tower
2 Chifley Square
Sydney NSW 2000

AUSTRALIA

When making a return, please ensure the product is properly packaged so as to ensure that no damage occurs to the product during transit.

Please provide the original or a copy of the proof of purchase. Also please make sure you have included an explanation of the problem.

Please note that the costs of making a warranty claim, including any return postage, will be covered by the supplier identified above.

Please note that upon receiving your warranty claim, the supplier will send, via the post or email, a repair and refurbished goods or parts notice. Please provide your email address and advise the supplier, if you wish to obtain a repair and refurbished goods or parts notice via email.



AFTER SALES SUPPORT

 1800 13 1579 (toll-free service hotline)

 service@produktservice.info

MODEL: AA5-CDAT-2A/2B/2C/2D

PRODUCT CODE: 92072

03/2015

CUSTOMER *Service*



Please note: For organizational reasons, we **cannot accept any unannounced packages** not prepaid.

Please **use our service home page first** or contact us through the **e-mail address** below or the toll-free **service hotline**.

Please have the **model no.** ready, which can be found either **on the back or on the bottom** of the product.



www.produktservice.info



service@produktservice.info



Toll-free service hotline
1800 13 1579

ALDI guarantees that our exclusive brand products are developed to our stringent quality specifications. If you are not entirely satisfied with this product, please return it to the nearest ALDI store within 60 days form the date of purchase, for a full refund or replacement, or take advantage of our after sales support by calling the supplier´s Customer Service Hotline.



AUS

Made in China

Crane is a registered trademark of ALDI Stores

Distributed By:

Aldi Stores

1 Sargents Road

Minchinbury nsw 2770

www.aldi.com.au

AFTER SALES SUPPORT

W¹



1800 13 1579



service@produktservice.info

Model: AA5-CDAT-2 A /2B/2C/2D Product code: 92072

03/2015

3
YEARS
WARRANTY